

emote

reference guide

01.27.2020

teknion

what is emote



what is emote

Emote transforms the private office into the creative office, one with a fresh look and the freedom to move and function in multiple ways.

Emote offers a new expressive language applied to wood furniture that surprises and inspires while maintaining the natural, tactile appeal of wood.

With Emote, one can make a statement, inspire creativity or offer a sense of home away from home.

Emote supports the agile worker with the freedom to function in multiple ways.



what is emote

Emote, designed by Mario Ruiz, is a collection of 21 distinct furniture elements that includes desks, cabinets, towers, thought boards and accessories.

TABLES



EMTF



EMTW



EMTB

STORAGE & TOWERS



EMMP



EMMS



EMC1



EMC2



EMC3



EMCC



EMCW



EMCM



EMCH



EMT1



EMT3

WALL- MOUNTED SCREENS & ACCESSORIES



EMDS



EMWS



EMWW

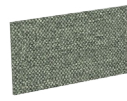

EMWT



EMWG



EMWA

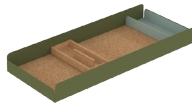

EMOM

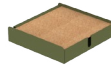

EMPW

emote finishes

Chroma wood and paint finishes are exclusive to Emote. The woods consist of 14 bold and neutral paint colors applied to wood veneer with an open pore grain finish to maintain the tactical and warm experience that natural wood grain texture provides.

CHROMA WOOD

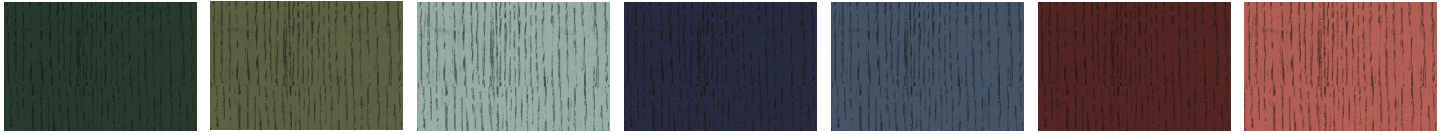

Forest (1M)

Loden (1G)

Herbal (1F)

Midnight (1L)

Atmosphere (1H)

Claret (1K)

Blush (1J)

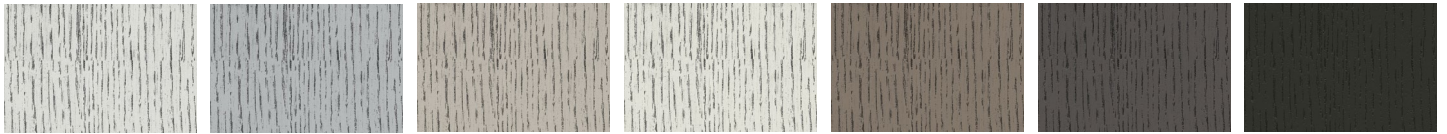

Crisp Grey (1Q)

Soft Gris (1P)

Sand (1T)

Atrium White (1S)

Earth (1R)

Greystone (1N)

Authracite (1U)

CHROMA PAINT



Atmosphere (CJ)

Herbal (CP)

Loden (CH)

Blush (CK)

emote finishes

A collection of distinct furniture elements, Emote brings a new expressive language to the workspace through a finish palette that surprises and inspires, while maintaining the natural, tactile appeal of wood. Transform the private office into the creative office by playing with neutral, contrasting or bold color combinations to convey a desired personality or culture.

What does your Emote office have to say?

- Emote finishes and furniture options allow for individual and corporate expression



home away from home



show your true colors



freedom of expression



make a statement

emote tables

PRODUCT FEATURES

Emote tables are available in 2 options:

1. Wood Top with Solid Wood Legs (EMTF)
 - Optional modesty available
 - Power bar with cable tray included
 - Wire management strip included
2. Wood Top with Height-Adjustable Base
 - Top with optional modesty (EMTW) and Base (EMTB) are sold separately
 - Switches, power bar and wire management options available with base

FINISHES

Top and Modesty Finish:	Chroma Wood, Veneer 4, Flintwood
Solid Wood Legs Finish:	Chroma Wood and Veneer 4
Height-Adjustable Base Finish:	Foundation Mica Accent Chroma Metal Paint

EDGE DETAILS

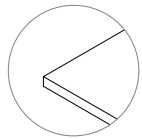

Rectangle Top
Square Edge

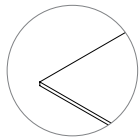

Rectangle Top
Knife Edge

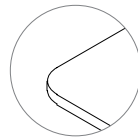

Eased Corners
Square Edge
Corner Radius: 2.875"

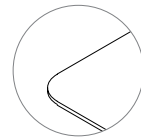

Eased Corners
Knife Edge
Corner Radius: 2.875"

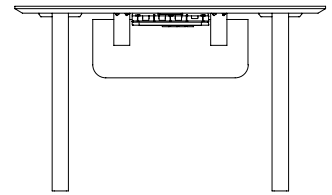
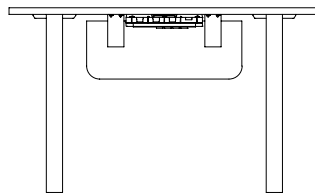
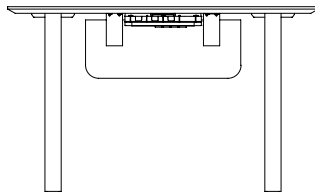
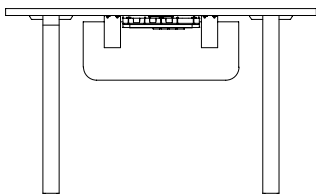

MODESTY OPTIONS

Emote worksurfaces are available with an optional modesty panel. The Modesty Panel can be placed in two locations determined on site.

- Recessed 3.5"
- Recessed 8"

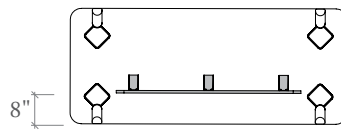
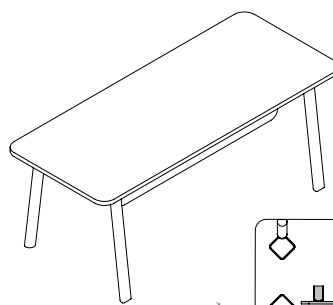
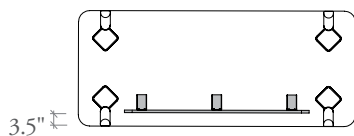
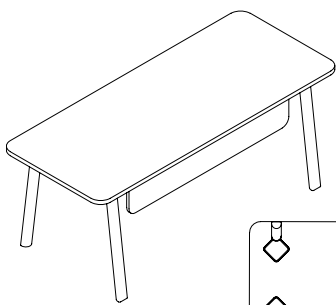

This 8" Recess is not available for:

- Fixed-Height Tables 24" deep
- Height-Adjustable Navigate Table Bases

POWER OPTIONS

Integrated power bars can be mounted onto either a modesty or under a worksurface on the Emote Table with Wood Legs and include:

- A power bar with 4 outlets
- A cable management tray
- A wire manager

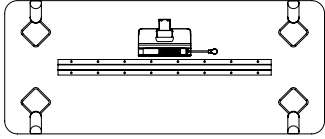

Worksurface mounted

- When no modesty panel is specified

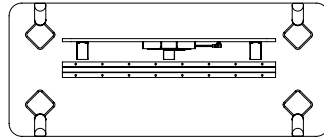

Modesty Panel mounted with 8" recess

- Wire manager will be mounted to the modesty panel

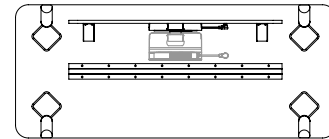

Modesty Panel mounted with 3.5" recess

- 24" deep worksurface, mounts to the modesty panel
- 30" deep worksurface, mounts either to the modesty panel or the worksurface

The included wire management strip helps to guide wires down one of the table legs.

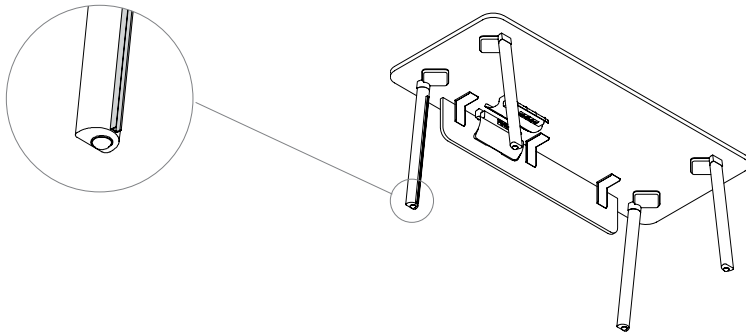

Cross channel integrated power bars are available on Height-Adjustable tables:

- 54" - 72" width

They can be mounted either on a modesty or worksurface.

An E-Chain can also be specified with the Height-Adjustable Base (EMTB) for addition wire management down to the floor.

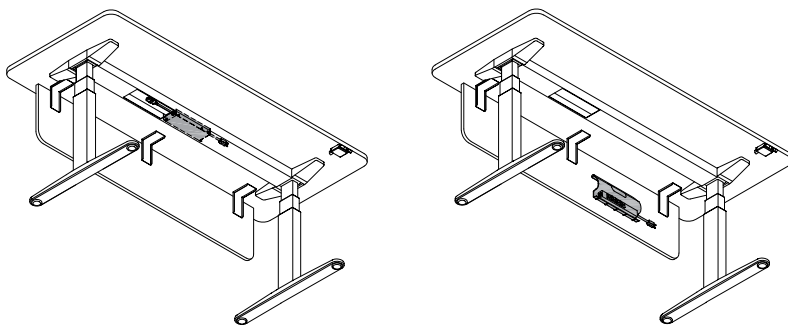

emote tables

TABLE WITH WOOD LEGS (EMTF)



PRODUCT DETAILS

Height: 29"
 Depths: 24", 30"
 Widths: 48", 54", 60", 66", 72"

Top Styles: Rectangular Top, Square Edge
 Eased Corners, Square Edge
 Rectangular Top, Knife Edge
 Eased Corners, Knife Edge

Under surface power bar, cable management tray and wire manager included.

Pricing is for a complete table.

Modesty finish can be specified separately.

TABLE WITH WOOD LEGS (EMTF) PRICING

Dimensions	Chroma Wood / Veneer 4 / Flintwood				
	Rectangle Top, Square Edge	Rectangle Top, Knife Edge	Eased Corners, Square Edge	Eased Corners, Knife Edge	Modesty Option
24" d x 48" w	2090	2218	2196	2282	551
24" d x 54" w	2137	2269	2244	2333	555
24" d x 60" w	2185	2321	2293	2385	593
24" d x 66" w	2232	2372	2341	2436	630
24" d x 72" w	2279	2424	2390	2488	667
30" d x 48" w	2226	2366	2338	2430	518
30" d x 54" w	2280	2425	2394	2489	555
30" d x 60" w	2335	2485	2450	2549	593
30" d x 66" w	2390	2544	2506	2608	630
30" d x 72" w	2444	2604	2562	2668	667

WORKSURFACE FOR NAVIGATE EXTENDED RANGE HEIGHT-ADJUSTABLE TABLE (EMTW)

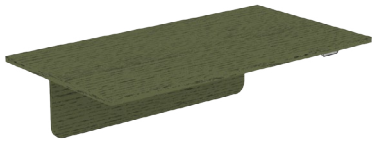

Shown in Chroma Wood



Shown in Flintwood

PRODUCT DETAILS

Depth: 30"
 Width: 48", 54", 60", 66", 72"

Top Styles: Rectangular Top, Square Edge
 Eased Corners, Square Edge
 Rectangular Top, Knife Edge
 Eased Corners, Knife Edge

Modesty finish can be specified separately when ordered.

WORKSURFACE FOR NAVIGATE EXTENDED RANGE HEIGHT-ADJUSTABLE TABLE (EMTW) PRICING

Dimensions	Chroma Wood / Veneer 4 / Flintwood				
	Top Only Eased Corners, Square Edge	Top Only Rect Top, Knife Edge	Top Only Eased Corners, Knife Edge	Top Only Rect Top, Square Edge	Modesty Only
30" d x 48" w	955	982	1045	845	485
30" d x 54" w	1010	1041	1103	899	520
30" d x 60" w	1064	1099	1162	952	555
30" d x 66" w	1119	1157	1220	1006	590
30" d x 72" w	1174	1215	1278	1059	625

emote tables

NAVIGATE HEIGHT-ADJUSTABLE FREESTANDING TABLE BASE ONLY (EMTB)

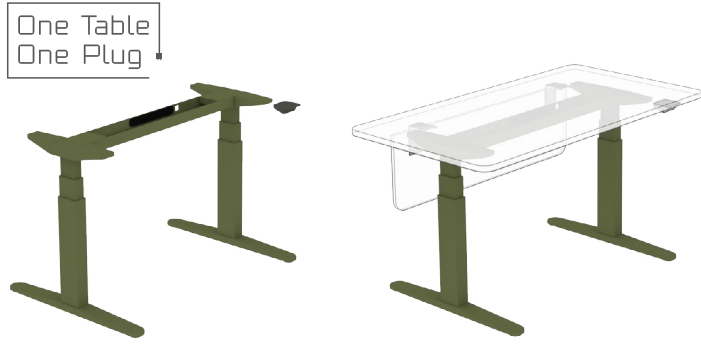

PRODUCT DETAILS

Widths: 48", 54", 60", 66", 72"
 Depths: 30"
 Height-Adjustable Range: 22.6" to 48.7"
 Base Mechanism: Extended Electric Emote

Power bar and wire management options available.

For more information about planning with IEC connection and height-adjustability, refer to Complements: *Teknion's Ergonomics & Accessories Program*.

NAVIGATE HEIGHT-ADJUSTABLE FREESTANDING TABLE BASE ONLY (EMTB) PRICING

Dimensions	Foundation Base	Mica / Accent / Chroma Paint Base
30" d x 48" w	1545	1591
30" d x 54" w	1545	1591
30" d x 60" w	1545	1591
30" d x 66" w	1550	1597
30" d x 72" w	1550	1597

Switch Options:

- Toggle Up/Down, add 36
- Display with Up/Down Memory, add 79
- Display Toggle with Memory & Navigate GPS, add 98

Power & Wire Management Options:

- Cross Channel Integrated Powerbar - 4 Outlets (no IEC) or 3 Outlets & 1 IEC, No Cable Management, add 105
- Cross Channel Integrated Powerbar - 4 Outlets (no IEC) or 3 Outlets & 1 IEC, Dual Plastic Trays, add 131
- Cross Channel Integrated Powerbar - 4 Outlets (no IEC), Dual Plastic Trays & Powerbar, add 227
- Cross Channel Integrated Powerbar - 4 Outlets (no IEC) or 3 Outlets & 1 IEC, Cable Organizer with Felt Cover, add 230
- Cross Channel Integrated Powerbar - 3 Outlets & 1 IEC, Dual Plastic Trays & Powerbar with IEC cord terminal, add 258
- Dual Plastic Trays, add 25
- Dual Plastic Trays & Powerbar, add 122
- Cable Organizer with Felt Cover, add 124
- E-Chain, add 142

PRODUCT FEATURES

- Cabinets and Towers are available in one size with multiple storage options:
 - Only the Work Cabinet has an optional integrated power, all others have no power options
- Cabinets are finished on all sides
- Elevated by a metal base (if applicable)
 - Metal base elevates the cabinet by 7.7"
- Optional locks
- Handedness is determined by the user's perspective or by the location of the door hinge
- To increase stability, High Cabinets and Towers should be anchored to the wall or adjacent storage
- Load capacity of single drawer configurations within for High Cabinets and Towers is 25 lbs.

FINISHES

Each individual Cabinet or Tower model is ONE PRICE regardless of the finish combination applied.

Finishes can be applied to four areas:

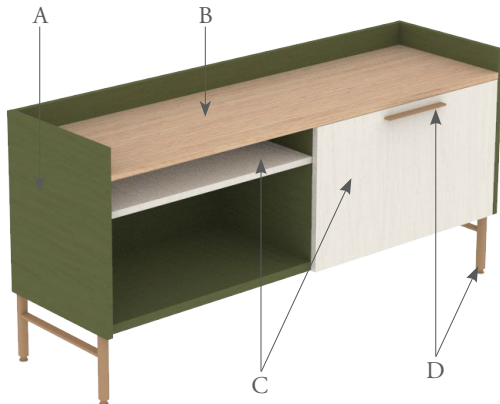

Four Areas for Application: A = Surround and Case Interior
 B = Top
 C = Door/Drawer Front and Shelves
 D = Handles and Base

ABC Finishes: Chrome Wood
 Veneer 4
 Flintwood

D Finishes: Chroma Metal Paint:
 - Herbal
 - Loden
 - Atmosphere
 - Blush

Metal Paints:
 - Atrium White
 - Anthracite
 - Graphite
 - Sepia Bronze
 - Burnished Bronze
 - Titanium Grey

emote storage & towers

MINI CABINET ON CASTERS (EMMP)





PRODUCT DETAILS

Width: 15"
 Depth: 16" (Actual 16.69")
 Height: 22"
 Storage Configuration: Open
 Single Door
 Small Drawer

Includes concealed casters.

MINI CABINET ON CASTERS (EMMP) PRICING

			
Dimensions	Open (OP)	Single Door (LC or RC)	Small Drawer (SD)
15"w x 16.69"d x 22"h	1549	1909	2065

Price is the same regardless of the finish combination

Lock option, add 81

MINI CABINET WITH SIDE ACCESS ON CASTERS (EMMS)





PRODUCT DETAILS

Width: 30"
 Depth: 16" (Actual 16.69")
 Height: 22"
 Storage Configuration: Open
 Single Door
 Small Drawer

Available with left or right handed side access which always has a single hinged door; the handedness is determined by user perspective.
 Includes concealed casters.

MINI CABINET WITH SIDE ACCESS ON CASTERS (EMMS) PRICING

			
Dimensions	Open (OP)	Single Door (LC or RC)	Small Drawer (SD)
15"w x 16.69"d x 22"h Cubby depth is 15"	2048	2696	2833

Price is the same regardless of the finish combination.

Cubby always has a hinged door.

Lock option, add 81

emote storage & towers



LOW SINGLE CABINET (EMC1)



PRODUCT DETAILS

Width: 29"
 Depth: 16.69"
 Height: 27.7"
 Storage Configuration:
 Open
 Partial Height Drawer
 Full Height Drawer
 Double Doors

LOW SINGLE CABINET (EMC1) PRICING

				
Dimensions	Open (OP)	Partial Height Drawer (PD)	Full Height Drawer (FD)	Double Doors (CL)
29"w x 16.69"d x 27.7"h	2133	2706	2739	2749

Price is the same regardless of the finish combination.
 Lock option, add 81

LOW DOUBLE CABINET (EMC2)



PRODUCT DETAILS

Width: 57.28"
 Depth: 16.69"
 Height: 27.7"
 Storage Configuration: Separate storage configurations can be specified on the right and left side of the cabinet.
 Open
 Double doors
 Partial height drawer
 Full height drawer

LOW DOUBLE CABINET (EMC2) PRICING

Left and Right Storage options include:



Open (OP)



Partial Height Drawer (PD)



Full Height Drawer (FD)



Double Doors (CL)

Left / Right Storage	Price
OP/OP	3166
CL/CL	4398
PD/PD	4313
FD/FD	4377
OP/CL, CL/OP	3782
OP/PD, PD/OP	3739
OP/FD, FD/OP	3772
CL/PD, PD/CL	4355
CL/FD, FD/CL	4387
PD/FD, FD/PD	4345

Price is the same regardless of the finish combination.

Lock option, add 81 each

emote storage & towers

LOW TRIPLE CABINET (EMC3)

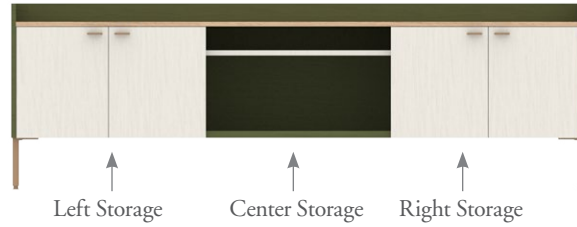

PRODUCT DETAILS

Width: 85.55"
 Depth: 16.69"
 Height: 27.7"
 Storage Configuration: Left, center and right storage space can be separately specified.
 Configurations include:
 Open
 Partial Height Drawer
 Full Height Drawer
 Double Doors

LOW TRIPLE CABINET (EMC3) PRICING

Left, Center and Right Storage options include:



Open (OP)



Partial Height Drawer (PD)



Full Height Drawer (FD)



Double Doors (CL)

Left / Center / Right Storage	Price
OP/OP/OP	4061
CL/CL/CL	5908
PD/PD/PD	5781
FD/FD/FD	5878
OP/OP/CL, OP/CL/OP, CL/OP/OP	4676
OP/OP/PD, OP/PD/OP, PD/OP/OP	4634
OP/OP/FD, OP/FD/OP, FD/OP/OP	4666

Left / Center / Right Storage	Price
OP/CL/CL, CL/OP/CL, CL/CL/OP	5292
OP/PD/PD, PD/OP/PD, PD/PD/OP	5207
OP/FD/FD, FD/OP/FD, FD/FD/OP	5272
CL/CL/PD, CL/PD/CL, PD/CL/CL	5866
CL/CL/FD, CL/FD/CL, FD/CL/CL	5898
PD/PD/CL, PD/CL/PD, CL/PD/PD	5866
PD/PD/FD, PD/FD/PD, FD/PD/PD	5813

Left / Center / Right Storage	Price
FD/FD/CL, FD/CL/FD, CL/FD/FD	5888
FD/FD/PD, FD/PD/FD, PD/FD/FD	5846
OP/CL/PD, OP/PD/CL, CL/OP/PD, CL/PD/OP, PD/OP/CL, PD/CL/OP	5250
OP/CL/FD, OP/FD/CL, CL/OP/FD, CL/FD/OP, FD/OP/CL, FD/CL/OP	5282
OP/PD/FD, OP/FD/PD, PD/OP/FD, PD/FD/OP, FD/OP/PD, FD/PD/OP	5240
CL/PD/FD, CL/FD/PD, PD/CL/FD, PD/FD/CL, FD/CL/PD, FD/PD/CL	5856

Price is the same regardless of the finish combination.

Lock option, add 81 each

emote storage & towers

LOW DOUBLE CABINET WITH CUBBY (EMCC)

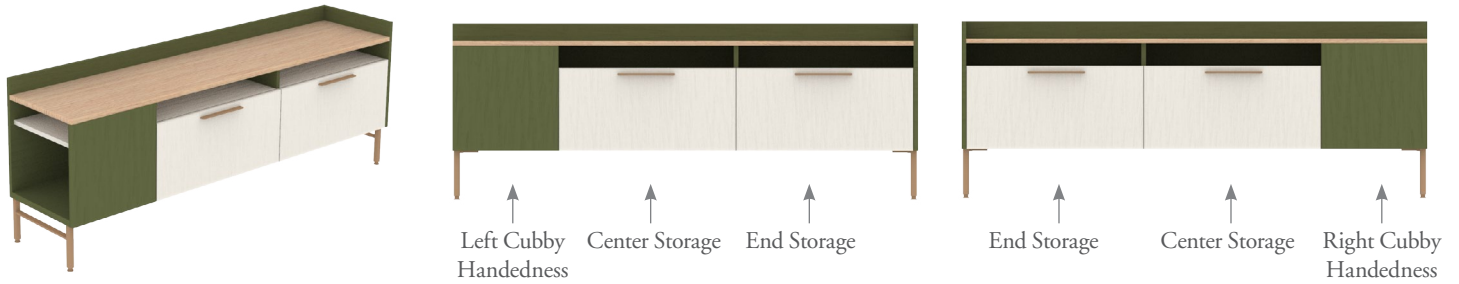

PRODUCT DETAILS

- Width: 73.25"
- Depth: 16.69"
- Height: 27.7"
- Storage Configuration: Center storage and end storage space can be separately specified.
- Configurations include:
 - Open
 - Partial Height Drawer
 - Full Height Drawer
 - Double Doors

Cubby is always open storage with single shelf and the handedness is determined from users perspective.

LOW DOUBLE CABINET WITH CUBBY (EMCC) PRICING

Center and End Storage options include:



Open (OP)



Partial Height Drawer (PD)



Full Height Drawer (FD)



Double Doors (CL)

Select End Storage, followed by Center Storage (End Storage will be opposite of the Cubby Handedness)	Price
OP/OP	3834
CL/CL	5065
PD/PD	4981
FD/FD	5045
OP/CL, CL/OP	4450
OP/PD, PD/OP	4407
OP/FD, FD/OP	4440
CL/PD, PD/CL	5023
CL/FD, FD/CL	5055
PD/FD, FD/PD	5013

Price is the same regardless of the finish combination.

Lock option, add 81 each

emote storage & towers

WORK CABINET (EMCW)



PRODUCT DETAILS

Width: 29"
 Depth: 16.69"
 Height: 45"
 Storage Configuration: Open
 Partial Height Drawer
 Full Height Drawer
 Lower closed
 Double Drawers

Optional integration power module is available, and includes a grommet cut out in the back of the unit and a wire manager.

Worksurface pulls out to provide a standing height surface and for access to power.
 Includes a grip on the underside of the surface.



WORK CABINET (EMCW) PRICING

				
Open (OP)	Partial Height Drawer (PD)	Full Height Drawer (FD)	Double Drawer (DD)	Lower Closed (LC)
3300	3874	4145	4447	4155

Price is the same regardless of the finish combination.

Integrated Power with 2 Power & USB, add 525

Lock option, add 81

MEDIUM SINGLE CABINET (EMCM)



PRODUCT DETAILS

Width: 29"
 Depth: 16.69"
 Height: 45"
 Storage Configuration:
 Open
 Double Doors
 Partial Height Drawer
 Full Height Drawer
 Double Drawers
 Lower Closed
 Drawer / Double Door Combo

MEDIUM SINGLE CABINET (EMCM) PRICING

Open (OP)	Double Doors (CL)	Partial Height Drawer (PD)	Full Height Drawer (FD)	Double Drawer (DD)	Lower Closed (LC)	Drawer / Double Doors Combo(DC)
2821	3616	3395	3675	3968	3685	4290

Price is the same regardless of the finish combination.

Lock option, add 81

emote storage & towers

HIGH SINGLE CABINET (EMCH)



PRODUCT DETAILS

Width:	29"
Depth:	16.69"
Height:	62.3"
Storage Configuration:	Open Fully Closed Drawer / Double Doors Full Height Drawer Double Drawers Partial Height Drawer

HIGH SINGLE CABINET (EMCH) PRICING

Open (OP)	Fully Closed (CF)	Drawer / Double Doors (DC)	Full Height Drawer (FD)	Double Drawer (DD)	Partial Height Drawer (PD)
3462	4474	4849	4336	4609	4035

Price is the same regardless of the finish combination.

Lock option, add 81

To increase stability, High Cabinets and Towers should be anchored to the wall or adjacent storage.

Load capacity of single drawer models within for High Cabinets and Towers is 25 lbs.

SINGLE TOWER (EMT1)



PRODUCT DETAILS

Width: 15"
 Depth: 16.69"
 Height: 62.3"
 Storage Configuration: Open
 Coat
 Closed full
 Lower drawer
 Lower drawer / Closed Upper

Available left or right handed.

SINGLE TOWER (EMT1) PRICING

				
Open (OP)	Coat (CT)	Closed Full (FC)	Lower Drawer (LD)	Lower Drawer / Closed Upper (DC)
2865	3031	3371	3985	3560

Price is the same regardless of the finish combination.

Lock option, add 81

To increase stability, High Cabinets and Towers should be anchored to the wall or adjacent storage.

Load capacity of single drawer models within for High Cabinets and Towers is 25 lbs.

emote storage & towers

TRIPLE TOWER (EMT3)



PRODUCT DETAILS

Width:	43.55"
Depth:	16.69"
Height:	62.3"
Storage Configuration:	Open Closed Full Lower Closed Lower Drawers Lower drawer - closed upper combo Coat-drawers combo / Coat-full closed combo Coat-lower closed combo Coat-open combo Coat-lower drawers-upper closed combo

Available left or right handed Coat only.

TRIPLE TOWER (EMT3) PRICING

Open (OP)	Closed Full (FC)	Lower Closed (LC)	Lower Drawer (LD)	Lower Drawer / Closed Upper (DC)
5280	6524	6607	7114	8381

Coat / Full Closed (CC)	Coat / Drawers (CD)	Coat / Open (CO)	Coat / Lower Closed (CW)	Coat / Lower Drawer / Upper Closed (CA)
6293	6751	5512	6413	7596

Price is the same regardless of the finish combination.

Lock option, add 81 each

emote wall-mounted screens & accessories

PRODUCT FEATURES

- Thought Boards and Wall Shelves are mounted to a wall to provide a variety of functions.
- Wall cleats for mounting to the wall, are in the form of J-Channels and are included with each unit
- Additional cleats (EMWA) can be specified separately for mounting multiple thought boards side by side at the same height
- The Wall Shelf with Thought Board has an 8" deep shelf designed for light storage or personal affects.
- Desktop shelves can be positioned on a worksurface or cabinet for maximum flexibility.

FINISHES

Thought Boards: Tackable
 Magnetic Wood
 Magnetic Backpainted Glass

Metal Organizers include a natural cork lining.

DESKTOP SHELF (EMDS)



PRODUCT DETAILS

Depth: 10"
 Width: 24", 30", 36", 42", 48", 54", 60"
 Overall Height with back accent: 6.25"
 Shelf Height: 3.5"
 Shelf finish: Chroma Wood
 Veneer 4
 Flintwood
 Back Accent and Legs finish: Chroma Paints
 Foundation
 Mica
 Accent

Metal legs are inset 5" from shelf edge for widths 24"-36" and inset 10" for widths 42"-60".

DESKTOP SHELF (EMDS) PRICING

Width	Price
24"	724
30"	800
36"	876
42"	953
48"	1052
54"	1128
60"	1204

Price is the same regardless of the finish combination.

emote wall-mounted screens & accessories

EMOTE WALL SHELF WITH THOUGHT BOARD (EMWS)



PRODUCT DETAILS

Height:	(14") 14.5", 29"
Shelf Depth:	8"
Overall Depth:	9"
Width:	29", 36", 42", 48"
Restriction:	29" height is only available 29" width
Top Accent finish:	Panel Fabrics Flintwood Chroma Wood Veneer Backpainted Glass
Metal Shelf:	Chroma Metal Paint Foundation Mica Accent colors

Top accent panel in wood or glass is magnetic.

All wall mounting hardware is included.

EMOTE WALL SHELF WITH THOUGHT BOARD (EMWS) PRICING

Dimensions	Flintwood / Chroma / Veneer 4 Top	Tackable, Gr.A Top	Tackable, COM / Gr.2 Top	Tackable, Gr.1 Top	Tackable, Gr.3 Top	Backpainted Glass Top
14.5"h x 29"w	641	517	540	529	557	732
14.5"h x 36"w	710	548	571	560	588	788
14.5"h x 42"w	780	585	608	597	625	878
14.5"h x 48"w	838	610	633	622	650	955
29" h x 29"w	833	560	583	571	600	992

Price is the same regardless of the finish combination.

emote wall-mounted screens & accessories

THOUGHT BOARD, MAGNETIC WOOD (EMWW)



PRODUCT DETAILS

Height:	(14") 14.5", 29"
Depth:	1"
Width:	(14") 14.5", 29", 36", 42", 48"
Restriction:	29" height is only available on 14.5" and 29"width
Finish:	Chroma Wood Flintwood Veneer 4

THOUGHT BOARD, MAGNETIC WOOD (EMWW) PRICING

Dimensions	Price
14.5"h x 14.5"w	471
14.5"h x 29"w	611
14.5"h x 36"w	676
14.5"h x 42"w	742
14.5"h x 48"w	795
29"h x 14.5"w	576
29"h x 29"w	803

Price is the same regardless of the finish combination

emote wall-mounted screens & accessories

THOUGHT BOARD, TACKABLE (EMWT)

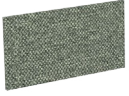

PRODUCT DETAILS

Height: (14") 14.5", 29"
Depth: 1"
Width: (14") 14.5", 29", 36", 42", 48"
Restriction: 29" height is only available with 14.5" and 29" width
Finish: Panel Fabrics

THOUGHT BOARD, TACKABLE (EMWT) PRICING

Dimensions	Grade A	Grade 1	COM / Grade 2	Grade 3
14.5"h x 14.5"w	424	436	447	464
14.5"h x 29"w	487	499	510	527
14.5"h x 36"w	514	526	537	554
14.5"h x 42"w	547	559	570	587
14.5"h x 48"w	567	579	590	607
29"h x 14.5"w	453	464	476	493
29"h x 29"h	530	541	553	570

emote wall-mounted screens & accessories

THOUGHT BOARD, MAGNETIC GLASS (EMWG)



PRODUCT DETAILS

Height:	(14") 14.5", 29"
Depth:	1"
Width:	(14") 14.5", 29", 36", 42", 48"
Restriction:	29" height is only available with 14.5" and 29" width
Finishes:	Very White Storm White Gris Graphic Steel

Backpainted Glass is a writable surface when paired with dry-erase marker.

All wall mounting hardware are included.

THOUGHT BOARD, MAGNETIC GLASS (EMWG) PRICING

Dimensions	Price
14.5"h x 14.5"w	497
14.5"h x 29"w	702
14.5"h x 36"w	754
14.5"h x 42"w	840
14.5"h x 48"w	912
29"h x 14.5"w	668
29"h x 29"h	962

Price point is the same regardless of the finish.

emote wall-mounted screens & accessories

THOUGHT BOARD, ADDITIONAL WALL CLEAT (EMWA)



PRODUCT DETAILS

Width: 29", 36", 42", 48", 54", 60", 66", 72", 78", 84", 90"

Channel Finish: Silver

The J-Channel wall mounting hardware eases with the installation of Thought Boards being placed side by side at the same height.

Multiple thought boards can be mounted onto the same rail.

THOUGHT BOARD, ADDITIONAL WALL CLEAT (EMWA) PRICING

Width	Price
29"	155
36"	164
42"	172
48"	181
54"	191
60"	201
66"	231
72"	241
78"	251
84"	282
90"	291

emote wall-mounted screens & accessories

EMOTE ORGANIZERS (EMOM)



PRODUCT DETAILS

All trays include natural cork liner.

Emote Organizers are available in bundles.

- A Cork Organizer is included with all tray bundles (excluding the Two Medium Trays M2)
- The Mini Cabinet Bundle includes a Medium and Small Tray Bundle and only one Cork Organizer

Finishes:
 Chroma Metal Paint
 Foundation
 Mica
 Accent Colors

EMOTE ORGANIZERS (EMOM) PRICING

Large Tray Bundle (LT)	Medium Tray Bundle (MT)	Small Tray Bundle (ST)	Mini Cabinet Bundle (CT)	Two Medium Trays (M2)	Cork Organizer (CO)
98	96	81	139	96	38

Price point is the same regardless of the finish.

emote wall- mounted screens & accessories

EMOTE POWER TRAY (EMPW)

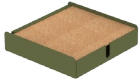

PRODUCT DETAILS

Easily placed on a Desk, Cabinet or within a Emote Organizer.

Integrated Power Module includes 2 Power Outlets, 1 USB-A, 1 USB-C.

Outlets in Platinum finish only.

The access lid is removable; to expose power.

Cork Inlay.

Cord Length: 10ft

Finishes: Chroma Metal Paint

Foundation

Mica

Accent Colors

EMOTE POWER TRAY (EMPW) PRICING

Price
318