

C+D

reference guide

09.28.2020



teknion

what is C+D

The C+D - Craft+Design - Conference Table program brings an artisanal focus back into the boardroom, while addressing the various connectivity needs of the contemporary workplace.

Thoughtful craftsmanship comes into play with the materials in the layered top and in the details of its different edge profiles and various leg options that support its large format.

Clever wire management and power are integrated to satisfy all the connectivity needs that versatile workspaces demand.

The C+D's numerous elements, with details that balance artisan craft and function, allow companies to customize the conference tables to fit their own distinct identity.



C&D, Craft & Design, is a collection of tables designed by Mario Ruiz. These tables are available within the Custom Wood catalog, which also features Boardroom Credenzas that compliment the tables with a similar finish offering.

TABLES



CWTK - Knife Edge



CWTF - Flat Edge



CWTM - Flat Wood and Metal Edge



CWTP - Extended Knife
with Edge Power



CWTK - Knife Edge
with runner and surface power



CWTF - Flat Edge
with runner and surface power



CWTM - Flat Wood and Metal Edge
with runner and surface power

CREDENZAS



CWSC - 1/2" top Credenza,
Closed Cabinet



CWSD - 1/2" top Credenza,
Drawer and Closed Cabinet

what is C+D

PRODUCT FEATURES

- C+D tables are available in a wide array of standard sizes, options and finishes which may also serve as inspiration for custom applications
- Edges are available in four profiles
- Legs are available in four options
- An accent runner is available with 18" power module
- Power options and leg styles support meeting spaces with light or heavy usage
- Wire routing within the Leg options are available through removable exterior accent panels on the leg exterior or in between infill panels.
- Depths: 48", 54", 60"
- Widths: 96" to 240" in 12" increments

LEG OPTIONS

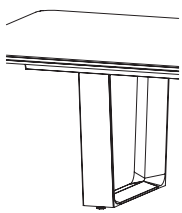

Standard Open (O)

- Depth 150mm
- Available on tables up to 16' wide
- Wire routes through the leg
- Finishes can be applied to two areas

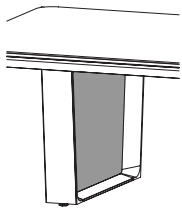
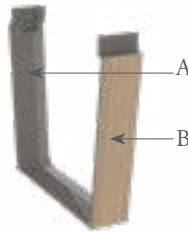

Standard with Infill (S)

- Depth 150mm
- Has a single infill panel
- Available on tables up to 18' wide
- Wire routes through the leg
- Finishes can be applied to three areas

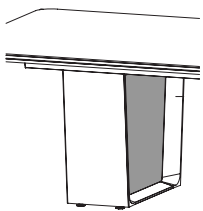
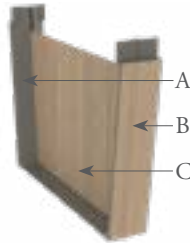

Thick with Infill (T)

- Depth 300 mm
- Has a double infill panel
- Available on tables between 10' and 20' wide
- Wire routes between the legs and infill panels
- Finishes can be applied to three areas

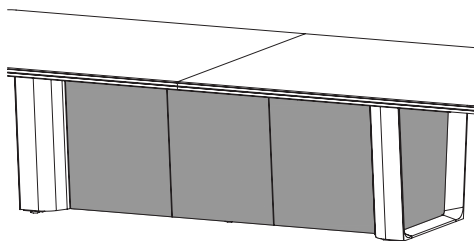
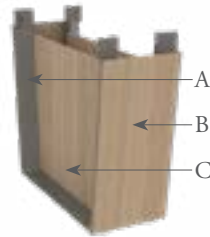

Fully Enclosed (F)

- Depth 150mm
- Has infill panels at both ends with centrally located access panel to interior
- Available on tables between 10' and 20' wide and 54" or 60" deep
- Finishes can be applied to three areas

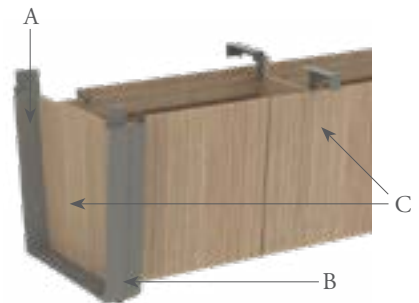

Leg Finish Options:

- A = Leg Metal Finish
 - 7 standard metal paints
- B = Leg Exterior Finish
 - Veneer 4 exterior accent
 - Matching metal paint finish in A
- C = Leg Infill Finish
 - Veneer 4 infill panel
 - Painted MDF surface to coordinate with metal paint finish in A

SURFACE POWER OPTIONS

Available for all tables, except the Extended Knife with Edge Power Table (CWTP)



Surface Power Module

- 18" long, centered on each worksurface section
- Each module includes:
 - 4 power outlets
 - 4 USB charging ports (2 USB-A type and 2 USB-C type)
 - 2 data knockouts
- Power cord length is 180"
- Finishes: Anthracite or Atrium White
- Finishes when paired with a Runner:
 - Atrium White is paired with the White Runner
 - Anthracite is paired with the Dark Runner

Blue = USB
Red = Power

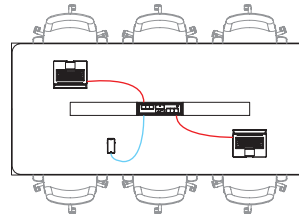

Surface Power with Runner

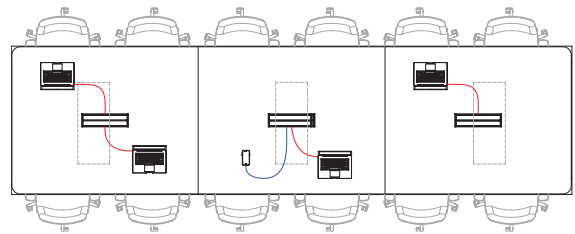

Surface Power without Runner

what is C+D

EDGE POWER OPTIONS



Table Width Edge Power
Power & USB (A & C)



Table End Power
Power & USB (A & C)

- Available on the Extended Knife with Edge Power Table (CWTP)
- Available mounting options:
 - Table End (E) and Both Table Ends (G), with large (four port) corded modules that include:
 - 3 Power Outlets
 - 2 USB charging ports (1 USB-A type & 1 USB-C type)
 - Table Width (T) and Table Width x2 (H), with small (two port) modules each with a corded transformer. Each table width module includes:
 - 1 Power Outlet
 - 2 USB charging ports (1 USB-A type & 1 USB-C type)
 - Visible metal shroud is finished to match leg finish
 - Power and USB receptacles are always Soft Gris

Blue = USB
Red = Power

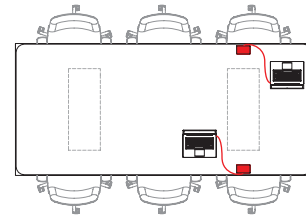

Edge Power - Table Width (T)

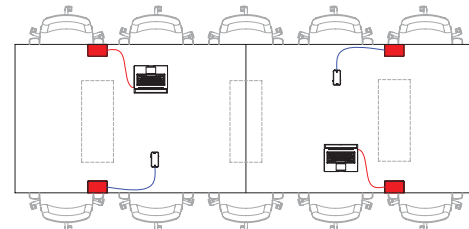

Edge Power - Table Width x 2 (H)

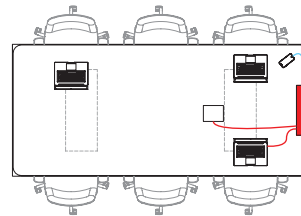

Edge Power - Table End (E)

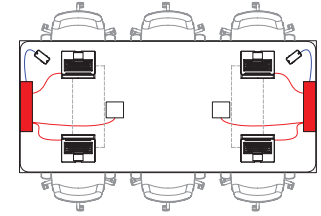

Edge Power - Both Table Ends (G)



Edge USB
USB-A & USB-C

- Available on the Flat Wood and Metal Edge Table (CWTM)
- Positioned centered to the legs
- 4 or 6 modules are available, depending on the table size
 - 17'-20' width tables have 6 modules
- USB module is always Black

Blue = USB
Red = Power

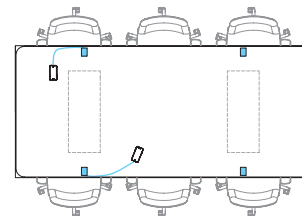

Edge USB

COMBINATION POWER OPTIONS

Wood and Metal Edge Table (CWTM)



Surface Power Module

- Surface module is not available with a runner when used in a combo application
- Surface module is selectable as either a Black or White finish:
 - Black finish is Anthracite
 - White finish is Atrium White



Edge USB
USB-A & USB-C

- Visible metal shroud is finished to match leg finish
- Power and USB receptacles are always Soft Gris

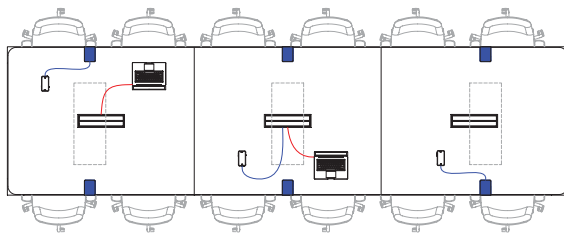

Blue = USB
Red = Power

Combo: Surface Power, 6 USB Edge, No Runner

Extended Knife with Edge Power (CWTP)



Surface Power Module

- Surface Module is not available with a runner when used in a combo application
- Surface Module is selectable as either a Black or White Finish:
 - Black finish is Anthracite
 - White finish is Atrium White

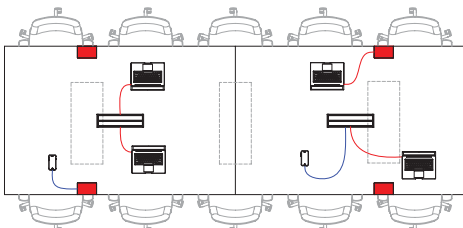

Table Width Edge Power
Power & USB (A & C)

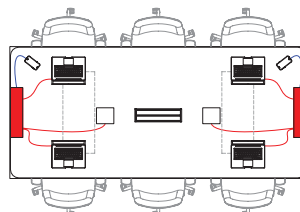

Table End Power
Power & USB (A & C)

- When specified in a combo application with Surface Power, Edge Power Modules can be mounted in two locations:
 - Both Table Ends (K, R) with 2 large (four port) corded modules
 - Table Width x2 (Q, V) with 4 small (two port) modules
- Visible metal shroud is always finished to match leg finish
- Power and USB receptacles are always Soft Gris



Combo Power: Surface and Table Width x 2,
4 Edge Power Modules



Blue = USB
Red = Power

Combo Power: Surface and Both Table Ends,
2 End Power Modules

what is C+D

CORNER STYLES

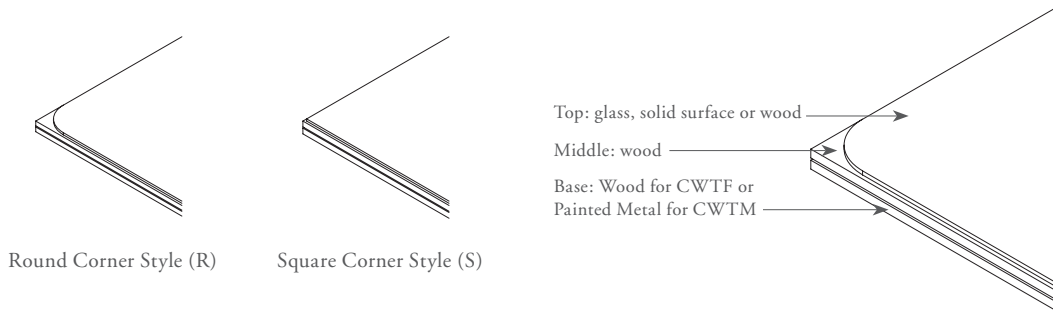

EDGE PROFILES

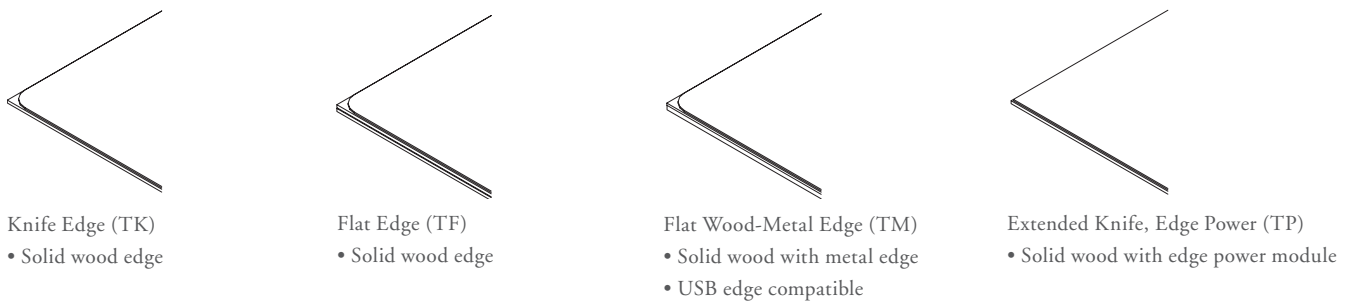

CABLE MANAGEMENT

The following cable management options are included with each table.

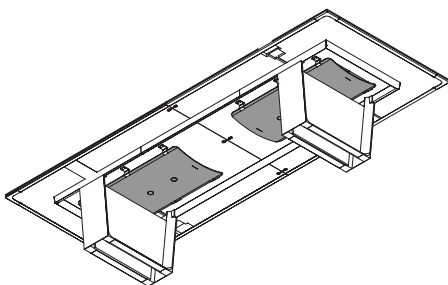

Flexible PET Tiles

- PET tiles cover cables managed under the worksurface and are included as a standard for tables with Standard Open (O), Standard with Infill (S) and Thick with Infill (T) leg styles only
- Available 36" and 48" wide;
 - the quantity and size varies by table length
- Fits loosely to the brackets below the table
- Ends are capped by a crescent shaped metal shroud
- Bracket Finish: Granite

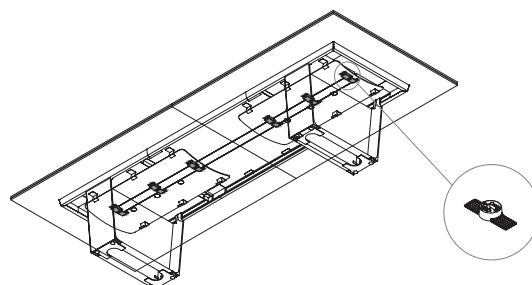

Under Worksurface Wire Clips and Cable Wraps

- Wire Clips and Cable Wraps are mount below the worksurface to manage and coil excess wires
- Also includes a detachable P-Clip for small wires
- 1 package of six clips is included with every table
- 2, 4, or 6 cable wraps are included with each table;
 - number of cable wraps included depends on table length

TABLE SECTIONS

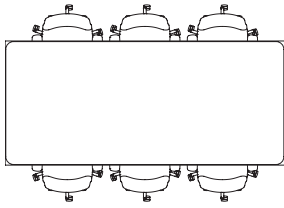

8'-9' tables have one worksurface section

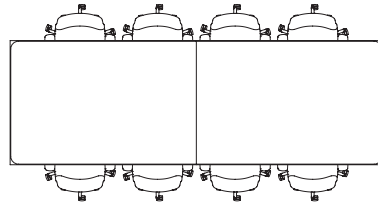

10'-16' tables have two worksurface sections

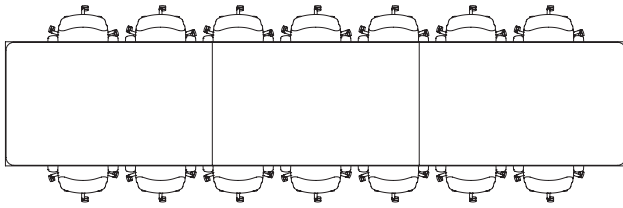

17'-20' tables have three worksurface sections

RECOMMENDED OCCUPANCY



8'-9' tables
6-8 people



13'-16' tables
12-14 people



10'-12' tables
8-10 people



17'-20' tables
14-16 people

finishes

TOP FINISH

- Veneer 4
- CWS (Custom Wood Stain)
- Solid Surface
- Backpainted Glass
- Etched Backpainted Glass



WOOD EDGE FINISH

- Veneer 4
- CWS (Custom Wood Stain)

RUNNER FINISHES

- Glacier White (W)
- Deep Titanium (D)

LEG METAL FINISH



LEG EXTERIOR FINISH

- Veneer 4
- CWS (Custom Wood Stain)
- Metal Paint Coordinate to match Leg Metal Finish

LEG INFILL FINISH

- Veneer 4
- CWS (Custom Wood Stain)
- Painted MDF Surface Coordinate to match Leg Metal Finish

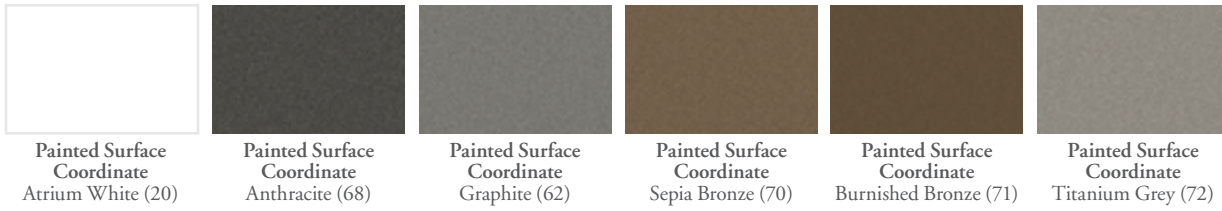

CREDENZA TOP FINISH

- Veneer 4
- CWS (Custom Wood Stain)
- Solid Surface
- Backpainted Glass



CREDENZA CASE FINISH

- Veneer 4
- CWS (Custom Wood Stain)
- Foundation Laminate



PULL FINISH



C+D tables

C+D TABLE, KNIFE EDGE (CWTK)



Round Corner Style shown



Standard Open (O)



Standard with Infill (S)



Thick with Infill (T)



Fully Enclosed (F)

C+D TABLE, KNIFE EDGE (CWTK), POWER OPTIONS PRICING

Widths	# of Modules	Surface Power Options for Table with Knife Edge			
		Black or White Surface Power Only (for Veneer and Solid Surface)	Black or White Surface Power Only (for Glass)	Glacier White Runner with Surface Power	Deep Titanium Runner with Surface Power
96" - 108"	1	819	1945	1748	2027
120" - 192	2	1637	1889	3433	3992
180" - 192	2	1637	1889	3810	4416
204" - 240"	3	2456	2834	4872	5599

A runner is not available on glass tops.

C+D TABLE, KNIFE EDGE (CWTK) PRICING

		Round Corner Style (R), Standard Open Leg (O)				
Depth	Width	Veneer Top	Backpainted Glass Top	Etched Backpainted Glass Top	White Solid Surface Top	Grey Solid Surface Top
48"	96"	8886	10342	12011	12690	13961
48"	108"	9328	10958	12836	13269	14535
48"	120"	11870	13622	15697	15834	17094
48"	132"	12337	14264	16548	16440	17694
48"	144"	12804	14906	17399	20939	23490
48"	156"	13299	15575	18278	21293	23843
48"	168"	14886	17337	20248	22741	25289
48"	180"	15100	17726	20846	22816	25362
48"	192"	15799	18600	21930	23375	25921
54"	96"	9120	10750	12628	12946	14217
54"	108"	9582	11408	13522	13546	14811
54"	120"	12152	14122	16459	16139	17398
54"	132"	12640	14806	17378	16766	18019
54"	144"	13128	15491	18298	21285	23836
54"	156"	13643	16202	19244	21661	24210
54"	168"	15251	18006	21283	23129	25677
54"	180"	15486	18438	21950	23225	25771
54"	192"	16206	19354	23101	23805	26350
60"	96"	9914	11645	13716	13763	15035
60"	108"	10397	12345	14677	14385	15650
60"	120"	12820	15003	17600	16830	18089
60"	132"	13410	15808	18665	17559	18812
60"	144"	13919	16534	19653	22099	24650
60"	156"	15858	18691	22070	23898	26448
60"	168"	16389	19439	23080	24290	26838
60"	180"	16921	20188	24090	24682	27228
60"	192"	17452	20937	25099	25073	27619

For Square Corner Style in Veneer or Solid Surface, subtract 296

For Square Corner Style in Glass, subtract 368

Leg Veneer Exterior Accent Finish for Widths 96" - 156", add 207

Leg Veneer Exterior Accent Finish for Widths 168" - 192", add 311

C+D tables

C+D TABLE, KNIFE EDGE (CWTK) PRICING (CONTINUED)

Depth	Width	Round Corner Style (R), Standard with Infill Leg (S)				
		Veneer Top	Backpainted Glass Top	Etched Backpainted Glass Top	White Solid Surface Top	Grey Solid Surface Top
48"	96"	10053	11509	13178	13857	15128
48"	108"	10494	12125	14003	14436	15702
48"	120"	13037	14789	16864	17001	18261
48"	132"	13504	15431	17715	17607	18860
48"	144"	13971	16073	18566	22106	24657
48"	156"	14466	16742	19445	22460	25010
48"	168"	16636	19087	21998	24491	27039
48"	180"	16851	19476	22597	24566	27113
48"	192"	17550	20350	23680	25126	27671
48"	204"	20250	23082	26589	27541	30085
48"	216"	20757	23824	27554	32913	36741
54"	96"	10287	11917	13795	14113	15384
54"	108"	10749	12575	14689	14713	15978
54"	120"	13319	15289	17626	17306	18565
54"	132"	13807	15973	18545	17933	19186
54"	144"	14295	16658	19465	22452	25003
54"	156"	14810	17369	20411	22828	25377
54"	168"	17002	19757	23034	24879	27428
54"	180"	17237	20188	23700	24975	27522
54"	192"	17957	21104	24851	25555	28101
54"	204"	20685	23879	27828	27999	30543
54"	216"	21212	24670	28870	33391	37219
60"	96"	11095	12826	14897	14944	16215
60"	108"	11578	13526	15858	15565	16830
60"	120"	14000	16184	18780	18011	19270
60"	132"	14591	16988	19846	18740	19993
60"	144"	15100	17715	20833	23280	25831
60"	156"	17629	20461	23840	25669	28219
60"	168"	18160	21210	24851	26061	28609
60"	180"	18692	21959	25861	26453	28999
60"	192"	19223	22708	26870	26844	29390
60"	204"	22064	25607	29996	29401	31945
60"	216"	22613	26448	31115	34814	38642

For Square Corner Style in Veneer or Solid Surface, subtract 296

For Square Corner Style in Glass, subtract 368

Leg Veneer Exterior Accent Finish for Widths 96" - 156", add 207

Leg Veneer Exterior Accent Finish for Widths 168" - 216", add 311

C+D TABLE, KNIFE EDGE (CWTK) PRICING (CONTINUED)

Depth	Width	Round Corner Style (R), Thick with Infills Leg (T)				
		Veneer Top	Backpainted Glass Top	Etched Backpainted Glass Top	White Solid Surface Top	Grey Solid Surface Top
48"	120"	13783	15535	17610	17747	19007
48"	132"	14250	16177	18461	18353	19607
48"	144"	14717	16819	19312	22852	25403
48"	156"	15212	17488	20191	23206	25756
48"	168"	17755	20206	23117	25610	28158
48"	180"	17970	20595	23716	25685	28232
48"	192"	18669	21469	24799	26245	28790
48"	204"	21369	24201	27708	28660	31204
48"	216"	21876	24943	28673	34032	37860
48"	228"	22382	25625	29564	34399	38226
48"	240"	22889	26306	30453	34766	38591
54"	120"	14065	16035	18372	18052	19311
54"	132"	14553	16719	19291	18679	19932
54"	144"	15041	17404	20211	23198	25749
54"	156"	15556	18115	21157	23574	26123
54"	168"	18121	20876	24153	25998	28547
54"	180"	18356	21307	24819	26094	28641
54"	192"	19076	22223	25970	26675	29220
54"	204"	21804	24998	28947	29118	31662
54"	216"	22331	25789	29989	34510	38338
54"	228"	22859	26513	30948	34898	38725
54"	240"	23386	27237	31906	35286	39111
60"	120"	14746	16930	19526	18757	20016
60"	132"	15337	17734	20592	19486	20739
60"	144"	15846	18461	21579	24026	26577
60"	156"	18748	21581	24960	26788	29338
60"	168"	19279	22329	25970	27180	29728
60"	180"	19811	23078	26980	27572	30118
60"	192"	20342	24007	27989	27963	30509
60"	204"	23183	26726	31115	30520	33064
60"	216"	23732	27568	32234	35934	39762
60"	228"	24280	28333	33260	36342	40169
60"	240"	24829	29099	34288	36751	40576

For Square Corner Style in Veneer or Solid Surface, subtract 296

For Square Corner Style in Glass, subtract 368

Leg Veneer Exterior Accent Finish for Widths 96" to 156", add 331

Leg Veneer Exterior Accent Finish for Widths 168" to 240", add 496

C+D tables

C+D TABLE, KNIFE EDGE (CWTK) PRICING (CONTINUED)

		Round Corner Style (R), Fully Enclosed Leg (F)				
Depth	Width	Veneer Top	Backpainted Glass Top	Etched Backpainted Glass Top	White Solid Surface Top	Grey Solid Surface Top
54"	120"	17453	19423	21760	21440	22699
54"	132"	17960	20126	22698	22086	23339
54"	144"	18787	21150	23957	26944	29495
54"	156"	19576	22135	25177	27594	30143
54"	168"	20989	23744	27021	28866	31415
54"	180"	21511	24462	27974	29249	31796
54"	192"	22577	25724	29471	30176	32721
54"	204"	25592	28786	32735	32906	35450
54"	216"	26422	29880	34080	38601	42429
54"	228"	27093	30747	35182	39132	42959
54"	240"	27954	31805	36474	39854	43679
60"	120"	18168	20352	22948	22179	23438
60"	132"	18778	21175	24033	22927	24180
60"	144"	19626	22241	25359	27806	30357
60"	156"	22802	25635	29014	30842	33392
60"	168"	22185	25235	28876	30086	32634
60"	180"	23004	26271	30173	30765	33311
60"	192"	23882	27547	31529	31503	34049
60"	204"	27009	30552	34941	34346	36890
60"	216"	27861	31697	36363	40063	43891
60"	228"	28553	32606	37533	40615	44442
60"	240"	29435	33705	38894	41357	45182

For Square Corner Style in Veneer or Solid Surface, subtract 296

For Square Corner Style in Glass, subtract 368

Leg Veneer Exterior Accent Finish for Widths 54" - 156", add 841

Leg Veneer Exterior Accent Finish for Widths 168" - 240", add 1006

C+D TABLE, FLAT EDGE (CWTF)



Round Corner Style shown



Standard Open (O)



Standard with Infill (S)



Thick with Infill (T)



Fully Enclosed (F)

C+D TABLE, FLAT EDGE (CWTF), POWER OPTIONS PRICING

Widths	# of Modules	Surface Power Options for Table with Flat Edge			
		Black or White Surface Power Only (for Veneer and Solid Surface)	Black or White Surface Power Only (for Glass)	Glacier White Runner with Surface Power	Deep Titanium Runner with Surface Power
96"-108"	1	819	1945	1748	2027
120"-192	2	1637	1889	3433	3992
180"-192	2	1637	1889	3810	4416
204"-240"	3	2456	2834	4872	5599

A runner is not available on glass tops.

C+D tables

C+D TABLE, FLAT EDGE (CWTF) PRICING

		Round Corner Style (R), Standard Open Leg (O)				
Depth	Width	Veneer Top	Backpainted Glass Top	Etched Backpainted Glass Top	White Solid Surface Top	Grey Solid Surface Top
48"	96"	8764	10220	11888	12567	13839
48"	108"	9197	10828	12706	13139	14404
48"	120"	11669	13421	15497	15634	16893
48"	132"	12129	14056	16340	16232	17485
48"	144"	12589	14690	17184	20723	23274
48"	156"	13075	15351	18054	21070	23619
48"	168"	14654	17105	20017	22509	25058
48"	180"	14861	17487	20607	22576	25123
48"	192"	15553	18353	21683	23128	25674
54"	96"	8995	10626	12504	12821	14093
54"	108"	9449	11276	13389	13414	14679
54"	120"	11949	13920	16257	15937	17196
54"	132"	12430	14596	17168	16556	17809
54"	144"	12910	15273	18080	21067	23618
54"	156"	13418	15977	19019	21435	23985
54"	168"	15018	17773	21050	22896	25444
54"	180"	15245	18196	21708	22983	25530
54"	192"	15958	19105	22852	23556	26102
60"	96"	9589	11319	13391	13438	14709
60"	108"	10064	12012	14344	14051	15317
60"	120"	12416	14600	17196	16427	17686
60"	132"	12996	15393	18250	17144	18397
60"	144"	13497	16112	19230	21677	24228
60"	156"	15331	18163	21542	23371	25921
60"	168"	15854	18905	22545	23755	26303
60"	180"	16378	19646	23547	24139	26686
60"	192"	16901	20387	24549	24523	27068

For Square Corner Style in Veneer or Solid Surface, subtract 296

For Square Corner Style in Glass, subtract 368

Leg Veneer Exterior Accent Finish for Widths 96" - 156", add 207

Leg Veneer Exterior Accent Finish for Widths 168" - 192", add 311

C+D TABLE, FLAT EDGE (CWTF) PRICING (CONTINUED)

		Round Corner Style (R), Standard with Infill Leg (S)				
Depth	Width	Veneer Top	Backpainted Glass Top	Etched Backpainted Glass Top	White Solid Surface Top	Grey Solid Surface Top
48"	96"	9931	11387	13055	13734	15005
48"	108"	10364	11995	13873	14306	15571
48"	120"	12836	14588	16664	16801	18060
48"	132"	13296	15223	17507	17399	18652
48"	144"	13756	15857	18351	21890	24441
48"	156"	14242	16518	19221	22237	24786
48"	168"	16405	18856	21767	24260	26808
48"	180"	16611	19237	22358	24327	26874
48"	192"	17303	20103	23433	24879	27424
48"	204"	19902	22734	26241	27193	29737
48"	216"	20401	23468	27198	32557	36385
54"	96"	10162	11793	13671	13988	15260
54"	108"	10616	12443	14556	14581	15846
54"	120"	13116	15087	17424	17104	18363
54"	132"	13597	15763	18335	17723	18976
54"	144"	14077	16440	19247	22234	24785
54"	156"	14585	17144	20186	22602	25152
54"	168"	16768	19523	22800	24646	27194
54"	180"	16996	19947	23459	24734	27281
54"	192"	17708	20855	24602	25307	27852
54"	204"	20335	23529	27478	27649	30193
54"	216"	20855	24313	28512	33034	36862
60"	96"	10769	12500	14571	14618	15890
60"	108"	11244	13193	15525	15232	16497
60"	120"	13597	15780	18377	17607	18867
60"	132"	14176	16573	19431	18325	19578
60"	144"	14677	17292	20410	22857	25408
60"	156"	17102	19934	23313	25142	27692
60"	168"	17625	20675	24316	25526	28074
60"	180"	18149	21417	25318	25910	28457
60"	192"	18672	22158	26320	26294	28839
60"	204"	21409	24951	29340	28745	31289
60"	216"	21950	25785	30451	34151	37979

For Square Corner Style in Veneer or Solid Surface, subtract 296

For Square Corner Style in Glass, subtract 368

Leg Veneer Exterior Accent Finish for Widths 96" - 156", add 207

Leg Veneer Exterior Accent Finish for Widths 168" - 216", add 311

C+D tables

C+D TABLE, FLAT EDGE (CWTF) PRICING (CONTINUED)

Depth	Width	Round Corner Style (R), Thick with Infills Leg (T)				
		Veneer Top	Backpainted Glass Top	Etched Backpainted Glass Top	White Solid Surface Top	Grey Solid Surface Top
48"	120"	13582	15334	17410	17547	18806
48"	132"	14042	15969	18253	18145	19398
48"	144"	14502	16603	19097	22636	25187
48"	156"	14988	17264	19967	22983	25532
48"	168"	17524	19975	22886	25379	27927
48"	180"	17731	20356	23477	25446	27993
48"	192"	18422	21222	24552	25998	28543
48"	204"	21021	23853	27360	28312	30856
48"	216"	21520	24587	28317	33676	37504
48"	228"	22019	25261	29200	34035	37862
48"	240"	22518	25935	30082	34395	38220
54"	120"	13862	15833	18170	17850	19109
54"	132"	14343	16509	19081	18469	19722
54"	144"	14823	17186	19993	22980	25531
54"	156"	15331	17890	20932	23348	25898
54"	168"	17887	20642	23919	25765	28313
54"	180"	18115	21066	24578	25853	28400
54"	192"	18827	21974	25722	26426	28971
54"	204"	21454	24648	28597	28768	31312
54"	216"	21974	25432	29631	34153	37981
54"	228"	22493	26148	30582	34533	38359
54"	240"	23013	26864	31533	34913	38738
60"	120"	14343	16526	19123	18353	19613
60"	132"	14922	17319	20177	19071	20324
60"	144"	15423	18038	21157	23603	26154
60"	156"	18221	21053	24432	26261	28811
60"	168"	18744	21794	25435	26645	29193
60"	180"	19268	22536	26437	27029	29576
60"	192"	19791	23277	27439	27413	29958
60"	204"	22528	26070	30459	29864	32408
60"	216"	23069	26904	31571	35270	39098
60"	228"	23609	27662	32589	35671	39498
60"	240"	24150	28421	33609	36072	39897

For Square Corner Style in Veneer or Solid Surface, subtract 296

For Square Corner Style in Glass, subtract 368

Leg Veneer Exterior Accent Finish for Widths 96" to 156", add 331

Leg Veneer Exterior Accent Finish for Widths 168" to 240", add 496

C+D TABLE, FLAT EDGE (CWTF) PRICING (CONTINUED)

Depth	Width	Round Corner Style (R), Fully Enclosed Leg (F)				
		Veneer Top	Backpainted Glass Top	Etched Backpainted Glass Top	White Solid Surface Top	Grey Solid Surface Top
54"	120"	17250	19221	21558	21238	22497
54"	132"	17750	19916	22488	21876	23129
54"	144"	18569	20932	23739	26726	29277
54"	156"	19351	21910	24952	27368	29918
54"	168"	20755	23510	26787	28633	31181
54"	180"	21270	24221	27733	29008	31555
54"	192"	22328	25475	29223	29927	32472
54"	204"	25242	28436	32385	32556	35100
54"	216"	26065	29523	33722	38244	42072
54"	228"	26727	30382	34816	38767	42593
54"	240"	27581	31432	36101	39481	43306
60"	120"	17765	19948	22545	21775	23035
60"	132"	18363	20760	23618	22512	23765
60"	144"	19203	21818	24937	27383	29934
60"	156"	22275	25107	28486	30315	32865
60"	168"	21650	24700	28341	29551	32099
60"	180"	22461	25729	29630	30222	32769
60"	192"	23331	26817	30979	30953	33498
60"	204"	26354	29896	34285	33690	36234
60"	216"	27198	31033	35700	39399	43227
60"	228"	27882	31935	36862	39944	43771
60"	240"	28756	33027	38215	40678	44503

For Square Corner Style in Veneer or Solid Surface, subtract 296

For Square Corner Style in Glass, subtract 368

Leg Veneer Exterior Accent Finish for Widths 54" - 156", add 841

Leg Veneer Exterior Accent Finish for Widths 168" - 240", add 1006

C+D tables

C+D TABLE, FLAT WOOD AND METAL, USB EDGE (CWTM)



Round Corner Style shown



Standard Open (O)



Standard with Infill (S)



Thick with Infill (T)



Fully Enclosed (F)

Solid wood and metal edge combination only includes USB when specified.

C+D TABLE, FLAT WOOD AND METAL, USB EDGE (CWTM) POWER OPTIONS PRICING

Widths	Edge USB Power Options	
	4 USB Edge Modules	6 USB Edge Modules
96" - 108"	1492	n/a
120" - 192"	1492	n/a
180" - 192"	1492	n/a
204" - 240"	1492	2513

Widths	Surface Power Options for Table with Flat Wood and Metal Edge				Combination of Surface & Edge Power		
	# of Surface Modules (if applicable)	Black or White Surface Power Only (for Veneer & Solid Surface)	Black or White Surface Power Only (for Glass)	Glacier White Runner with Surface Power	Deep Titanium Runner with Surface Power	Black or White Surface Power only with 4 USB Edge Modules	Black or White Surface Power only with 6 USB Edge Modules
96" - 108"	1	819	945	1748	2027	2437	n/a
120" - 192"	2	1637	1889	3433	3992	3381	n/a
180" - 192"	2	1637	1889	3810	4416	3381	n/a
204" - 240"	3	2456	2834	4872	5599	4326	5347

C+D TABLE, FLAT WOOD AND METAL, USB EDGE (CWTM) PRICING

		Round Corner Style (R), Standard Open Leg (O)				
Depth	Width	Veneer Top	Backpainted Glass Top	Etched Backpainted Glass Top	White Solid Surface Top	Grey Solid Surface Top
48"	96"	9762	11218	12887	13566	14837
48"	108"	10219	11849	13727	14161	15426
48"	120"	13004	14756	16831	16968	18228
48"	132"	13677	15604	17888	17781	19034
48"	144"	14215	16316	18810	22349	24900
48"	156"	14725	17001	19704	22719	25269
48"	168"	16327	18778	21689	24182	26730
48"	180"	16557	19183	22303	24272	26819
48"	192"	17272	20072	23402	24848	27393
54"	96"	10020	11651	13529	13846	15118
54"	108"	10498	12325	14438	14462	15728
54"	120"	13310	15281	17618	17298	18557
54"	132"	14005	16172	18744	18131	19384
54"	144"	14563	16926	19733	22720	25271
54"	156"	15094	17653	20695	23111	25661
54"	168"	16717	19472	22749	24595	27143
54"	180"	16968	19919	23431	24706	27253
54"	192"	18017	21165	24912	25616	28161
60"	96"	10828	12559	14630	14677	15948
60"	108"	11327	13275	15607	15314	16579
60"	120"	13992	16175	18772	18002	19261
60"	132"	14785	17182	20040	18934	20187
60"	144"	15364	17979	21097	23544	26095
60"	156"	17318	20151	23530	25358	27908
60"	168"	17865	20915	24556	25766	28314
60"	180"	18412	21679	25581	26173	28720
60"	192"	18959	22444	26606	26580	29125

For Square Corner Style in Veneer or Solid Surface, subtract 296

For Square Corner Style in Glass, subtract 368

Leg Veneer Exterior Accent Finish for Widths 96" - 156", add 207

Leg Veneer Exterior Accent Finish for Widths 168" - 192", add 311

C+D tables

C+D TABLE, FLAT WOOD AND METAL, USB EDGE (CWTM) PRICING (CONTINUED)

Depth	Width	Round Corner Style (R), Standard with Infill Leg (S)				
		Veneer Top	Backpainted Glass Top	Etched Backpainted Glass Top	White Solid Surface Top	Grey Solid Surface Top
48"	96"	10929	12385	14054	14732	16004
48"	108"	11386	13016	14894	15328	16593
48"	120"	14171	15922	17998	18135	19394
48"	132"	14844	16771	19055	18947	20201
48"	144"	15382	17483	19976	23516	26067
48"	156"	15892	18168	20871	23886	26436
48"	168"	18078	20528	23440	25932	28481
48"	180"	18307	20933	24054	26023	28570
48"	192"	19022	21823	25153	26598	29143
48"	204"	22238	25070	28577	29529	32073
48"	216"	22760	25828	29557	34917	38744
54"	96"	11187	12818	14696	15013	16285
54"	108"	11665	13492	15605	15629	16895
54"	120"	14477	16448	18785	18465	19724
54"	132"	15172	17339	19910	19298	20551
54"	144"	15730	18093	20900	23887	26438
54"	156"	16261	18820	21862	24278	26828
54"	168"	18468	21223	24500	26346	28894
54"	180"	18719	21670	25182	26457	29003
54"	192"	19768	22915	26662	27366	29912
54"	204"	22698	25892	29841	30012	32556
54"	216"	23241	26699	30898	35420	39248
60"	96"	12009	13739	15811	15858	17129
60"	108"	12507	14455	16787	16495	17760
60"	120"	15172	17356	19952	19183	20442
60"	132"	15966	18363	21220	20114	21368
60"	144"	16545	19159	22278	24724	27275
60"	156"	19089	21922	25301	27129	29679
60"	168"	19636	22686	26327	27536	30085
60"	180"	20183	23450	27352	27944	30490
60"	192"	20730	24215	28377	28351	30896
60"	204"	24083	27625	32014	31419	33963
60"	216"	24647	28483	33149	36849	40677

For Square Corner Style in Veneer or Solid Surface, subtract 296

For Square Corner Style in Glass, subtract 368

Leg Veneer Exterior Accent Finish for Widths 96" - 156", add 207

Leg Veneer Exterior Accent Finish for Widths 168" - 216", add 311

C+D TABLE, FLAT WOOD AND METAL, USB EDGE (CWTM) PRICING (CONTINUED)

		Round Corner Style (R), Thick with Infills Leg (T)				
Depth	Width	Veneer Top	Backpainted Glass Top	Etched Backpainted Glass Top	White Solid Surface Top	Grey Solid Surface Top
48"	120"	14917	16669	18744	18881	20141
48"	132"	15590	17517	19801	19694	20947
48"	144"	16128	18229	20723	24262	26813
48"	156"	16638	18914	21617	24632	27182
48"	168"	19197	21647	24559	27052	29600
48"	180"	19427	22052	25173	27142	29689
48"	192"	20141	22942	26272	27717	30262
48"	204"	23357	26189	29696	30648	33192
48"	216"	23879	26947	30677	36036	39864
48"	228"	24402	27644	31583	36418	40245
48"	240"	24924	28341	32488	36801	40626
54"	120"	15223	17194	19531	19211	20470
54"	132"	15918	18085	20657	20044	21297
54"	144"	16476	18839	21646	24633	27184
54"	156"	17007	19566	22608	25024	27574
54"	168"	19587	22342	25619	27465	30013
54"	180"	19838	22789	26301	27576	30123
54"	192"	20887	24034	27781	28485	31031
54"	204"	23817	27011	30960	31131	33675
54"	216"	24360	27818	32017	36539	40367
54"	228"	24903	28557	32992	36943	40769
54"	240"	25446	29297	33966	37346	41171
60"	120"	15918	18102	20698	19929	21188
60"	132"	16712	19109	21967	20860	22114
60"	144"	17291	19905	23024	25470	28021
60"	156"	20208	23041	26420	28248	30798
60"	168"	20755	23805	27446	28656	31204
60"	180"	21302	24569	28471	29063	31610
60"	192"	21849	25334	29496	29470	32015
60"	204"	25202	28744	33133	32539	35083
60"	216"	25766	29602	34268	37968	41796
60"	228"	26330	30383	35310	38392	42219
60"	240"	26894	31165	36353	38816	42641

For Square Corner Style in Veneer or Solid Surface, subtract 296

For Square Corner Style in Glass, subtract 368

Leg Veneer Exterior Accent Finish for Widths 96" to 156", add 331

Leg Veneer Exterior Accent Finish for Widths 168" to 240", add 496

C+D tables

C+D TABLE, FLAT WOOD AND METAL, USB EDGE (CWTM) PRICING (CONTINUED)

Depth	Width	Round Corner Style (R), Fully Enclosed Leg (F)				
		Veneer Top	Backpainted Glass Top	Etched Backpainted Glass Top	White Solid Surface Top	Grey Solid Surface Top
54"	120"	18611	20582	22919	22599	23858
54"	132"	19325	21492	24064	23451	24704
54"	144"	20222	22585	25392	28379	30930
54"	156"	21027	23586	26628	29044	31594
54"	168"	22455	25210	28487	30333	32881
54"	180"	22993	25944	29456	30731	33278
54"	192"	24388	27535	31282	31986	34532
54"	204"	27605	30799	34748	34919	37463
54"	216"	28451	31909	36108	40630	44458
54"	228"	29137	32791	37226	41177	45003
54"	240"	30014	33865	38534	41914	45739
60"	120"	19340	21524	24120	23351	24610
60"	132"	20153	22550	25408	24301	25555
60"	144"	21071	23685	26804	29250	31801
60"	156"	24262	27095	30474	32302	34852
60"	168"	23661	26711	30352	31562	34110
60"	180"	24495	27762	31664	32256	34803
60"	192"	25389	28874	33036	33010	35555
60"	204"	29028	32570	36959	36365	38909
60"	216"	29895	33731	38397	42097	45925
60"	228"	30603	34656	39583	42665	46492
60"	240"	31500	35771	40959	43422	47247

For Square Corner Style in Veneer or Solid Surface, subtract 296

For Square Corner Style in Glass, subtract 368

Leg Veneer Exterior Accent Finish for Widths 54" - 156", add 841

Leg Veneer Exterior Accent Finish for Widths 168" - 240", add 1006

C+D TABLE, EXTENDED KNIFE, EDGE POWER (CWTP)



Square Corner Style shown



Standard Open (O)



Standard with Infill (S)



Thick with Infill (T)



Fully Enclosed (F)

Available with Square Corner Style only.

Surface Power options are only available when specified together with Edge Power in a Combo Application.

Solid wood extended knife edge cannot be specified without End or Width power options.

C+D TABLE, EXTENDED KNIFE, EDGE POWER (CWTP) POWER OPTIONS PRICING

Widths	Surface Power Options for Table with Extended Knife, Edge Power				Combination of Surface & Edge Power		
	Table End Edge Power (1 Module)	Table Width Edge Power (2 Modules)	Both Table Ends Edge Power (2 Modules)	Table Width (x2) Edge Power (4 Modules)	# of Surface Modules (if applicable)	Black or White Surface Power with Both Table End Edge Power	Black or White Surface Power with Table Width (x2) Edge Power
96" - 108"	495	795	990	1590	1	1935	2535
120" - 192"	495	795	990	1590	2	2879	3479
180" - 192"	495	795	990	1590	2	2879	3479
204" - 240"	495	795	990	1590	3	3824	4424

A runner is not available on glass tops.

C+D tables

C+D TABLE, EXTENDED KNIFE, EDGE POWER (CWTP) PRICING

Depth	Width	Square Corner Style (S), Standard Open Leg (O)				
		Veneer Top	Backpainted Glass Top	Etched Backpainted Glass Top	White Solid Surface Top	Grey Solid Surface Top
48"	96"	9718	11144	12822	13636	14945
48"	108"	10198	11804	13692	14258	15561
48"	120"	13044	14774	16861	17127	18425
48"	132"	13551	15460	17758	17777	19067
48"	144"	14056	16147	18655	22435	25063
48"	156"	14591	16862	19580	22826	25452
48"	168"	16251	18702	21628	24342	26966
48"	180"	16498	19128	22265	24444	27067
48"	192"	17242	20053	23401	25045	27668
54"	96"	9965	11570	13459	13906	15215
54"	108"	10466	12273	14398	14550	15853
54"	120"	13341	15296	17645	17447	18745
54"	132"	13868	16026	18612	18118	19409
54"	144"	14396	16756	19578	22798	25426
54"	156"	14953	17514	20573	23210	25837
54"	168"	16633	19397	22692	24748	27372
54"	180"	16901	19867	23398	24871	27495
54"	192"	17669	20836	24603	25495	28116
60"	96"	10809	12518	14600	14773	16082
60"	108"	11331	13264	15609	15439	16742
60"	120"	14053	16229	18839	18185	19481
60"	132"	14700	17095	19968	18973	20264
60"	144"	15249	17868	21004	23675	26302
60"	156"	17271	20115	23512	25553	28179
60"	168"	17844	20911	24572	25982	28606
60"	180"	18416	21708	25630	26410	29034
60"	192"	18989	22504	26689	26839	29460

Leg Veneer Exterior Accent Finish for Widths 96" - 156", add 207

Leg Veneer Exterior Accent Finish for Widths 168" - 192", add 311

C+D TABLE, EXTENDED KNIFE, EDGE POWER (CWTP) PRICING (CONTINUED)

		Square Corner Style (S), Standard with Infill Leg (S)				
Depth	Width	Veneer Top	Backpainted Glass Top	Etched Backpainted Glass Top	White Solid Surface Top	Grey Solid Surface Top
48"	96"	10920	12346	14024	14838	16147
48"	108"	11400	13006	14894	15460	16763
48"	120"	14246	15976	18063	18329	19627
48"	132"	14753	16662	18960	18979	20269
48"	144"	15258	17349	19857	23637	26265
48"	156"	15793	18064	20782	24028	26653
48"	168"	18054	20504	23432	26144	28769
48"	180"	18300	20931	24068	26247	28870
48"	192"	19046	21856	25204	26849	29470
48"	204"	22154	24998	28523	29664	32284
48"	216"	22702	25787	29537	35223	39166
54"	96"	11167	12772	14661	15108	16417
54"	108"	11668	13475	15600	15752	17055
54"	120"	14543	16498	18847	18649	19946
54"	132"	15070	17228	19814	19320	20611
54"	144"	15598	17958	20780	24000	26628
54"	156"	16155	18716	21775	24412	27039
54"	168"	18437	21200	24495	26550	29176
54"	180"	18704	21670	25201	26675	29297
54"	192"	19471	22639	26407	27298	29919
54"	204"	22609	25824	29795	30142	32762
54"	216"	23177	26666	30887	35721	39664
60"	96"	12025	13733	15815	15990	17299
60"	108"	12547	14480	16824	16654	17958
60"	120"	15270	17444	20055	19400	20697
60"	132"	15916	18311	21184	20189	21480
60"	144"	16466	19085	22220	24891	27519
60"	156"	19095	21939	25336	27377	30003
60"	168"	19668	22735	26396	27806	30430
60"	180"	20241	23532	27454	28234	30858
60"	192"	20813	24329	28513	28663	31284
60"	204"	24080	27656	32066	31636	34257
60"	216"	24671	28547	33238	37239	41181

Leg Veneer Exterior Accent Finish for Widths 96" to 156", add 331

Leg Veneer Exterior Accent Finish for Widths 168" to 240", add 496

C+D tables

C+D TABLE, EXTENDED KNIFE, EDGE POWER (CWTP) PRICING (CONTINUED)

		Square Corner Style (S), Thick with Infills Leg (T)				
Depth	Width	Veneer Top	Backpainted Glass Top	Etched Backpainted Glass Top	White Solid Surface Top	Grey Solid Surface Top
48"	120"	15014	16745	18832	19097	20395
48"	132"	15521	17431	19728	19747	21038
48"	144"	16027	18118	20625	24406	27033
48"	156"	16561	18833	21550	24796	27423
48"	168"	19206	21657	24584	27297	29922
48"	180"	19453	22083	25221	27400	30022
48"	192"	20198	23009	26356	28002	30623
48"	204"	23308	26151	29676	30817	33437
48"	216"	23855	26940	30689	36375	40318
48"	228"	24402	27667	31627	36778	40720
48"	240"	24949	28394	32564	37182	41122
54"	120"	15311	17266	19615	19418	20715
54"	132"	15839	17996	20582	20088	21380
54"	144"	16367	18726	21549	24768	27396
54"	156"	16923	19485	22543	25180	27807
54"	168"	19590	22353	25648	27704	30328
54"	180"	19856	22823	26354	27828	30450
54"	192"	20624	23792	27559	28451	31072
54"	204"	23762	26977	30947	31294	33915
54"	216"	24331	27818	32040	36874	40817
54"	228"	24899	28589	33046	37299	41240
54"	240"	25468	29359	34054	37724	41664
60"	120"	16038	18213	20823	20168	21466
60"	132"	16684	19080	21952	20957	22248
60"	144"	17234	19853	22988	25659	28287
60"	156"	20249	23092	26489	28530	31155
60"	168"	20820	23888	27548	28958	31583
60"	180"	21393	24685	28607	29387	32010
60"	192"	21966	25481	29666	29815	32438
60"	204"	25233	28808	33219	32790	35410
60"	216"	25823	29700	34391	38391	42334
60"	228"	26413	30514	35467	38837	42778
60"	240"	27004	31328	36544	39283	43223

Leg Veneer Exterior Accent Finish for Widths 96" to 156", add 331
 Leg Veneer Exterior Accent Finish for Widths 168" to 240", add 496

C+D TABLE, EXTENDED KNIFE, EDGE POWER (CWTP) PRICING (CONTINUED)

Depth	Width	Square Corner Style (S), Fully Enclosed Leg (F)				
		Veneer Top	Backpainted Glass Top	Etched Backpainted Glass Top	White Solid Surface Top	Grey Solid Surface Top
54"	120"	18801	20756	23105	22907	24205
54"	132"	19349	21505	24091	23597	24889
54"	144"	20225	22585	25407	28627	31254
54"	156"	21064	23625	26683	29321	31948
54"	168"	22544	25307	28602	30658	33282
54"	180"	23106	26072	29603	31077	33700
54"	192"	24230	27398	31165	32057	34678
54"	204"	27664	30878	34849	35196	37816
54"	216"	28544	32032	36253	41088	45031
54"	228"	29260	32950	37407	41660	45601
54"	240"	30173	34064	38759	42429	46369
60"	120"	19563	21738	24348	23693	24991
60"	132"	20228	22624	25496	24502	25792
60"	144"	21127	23747	26881	29553	32180
60"	156"	24424	27267	30664	32706	35331
60"	168"	23814	26881	30542	31952	34576
60"	180"	24682	27974	31896	32676	35299
60"	192"	25612	29127	33312	33462	36084
60"	204"	29174	32749	37160	36731	39351
60"	216"	30076	33953	38644	42644	46587
60"	228"	30815	34915	39868	43238	47179
60"	240"	31748	36073	41288	44027	47967

Leg Veneer Exterior Accent Finish for Widths 54" - 156", add 841

Leg Veneer Exterior Accent Finish for Widths 168" - 240", add 1006

C+D credenzas

CREDENZA 1/2" TOP, CLOSED CABINET (CWSC)



PRODUCT FEATURES

- Heights:
 - 29"
 - 36"
- Depths:
 - 20"
 - 24"
- Widths:
 - Two storage section - 60", 72"
 - Three storage section: 90", 108"
- Horizontal or Vertical Grain Directions are the same price
- One internal shelf
- Optional Lock available in Ebony or Polished Chrome finish

CREDENZA 1/2" TOP, CLOSED CABINET (CWSC) PRICING

Height	Depth	Width	Laminate Case Construction			
			Veneer Top, Laminate Case	Backpainted Glass Top, Laminate Case	White Solid Surface Top, Laminate Case	Grey Solid Surface Top, Laminate Case
29"	20"	60"	5219	6271	6475	6850
29"	20"	72"	5536	6788	6916	7478
29"	20"	90"	7665	9186	9361	10111
29"	20"	108"	8180	9979	10112	10862
29"	24"	60"	5519	6526	6914	7289
29"	24"	72"	5927	7052	7501	8063
29"	24"	90"	8131	9566	10118	10868
29"	24"	108"	8657	10378	10977	11727
36"	20"	60"	6305	7357	7561	7936
36"	20"	72"	6702	7954	8082	8644
36"	20"	90"	9285	10806	10981	11731
36"	20"	108"	9937	11736	11869	12619
36"	24"	60"	6540	7547	7935	8310
36"	24"	72"	7060	8185	8634	9196
36"	24"	90"	9667	11102	11654	12404
36"	24"	108"	10357	12078	12677	13427

Lock Option add 81

CREDENZA 1/2" TOP, CLOSED CABINET (CWSC) PRICING (CONTINUED)

Height	Depth	Width	Veneer Case Construction			
			Veneer Top, Veneer Case	Backpainted Glass Top, Veneer Case	White Solid Surface Top, Veneer Case	Grey Solid Surface Top, Veneer Case
29"	20"	60"	6039	7091	7295	7670
29"	20"	72"	6466	7718	7846	8408
29"	20"	90"	8888	10409	10584	11334
29"	20"	108"	9573	11372	11505	12255
29"	24"	60"	6427	7434	7822	8197
29"	24"	72"	6927	8052	8501	9063
29"	24"	90"	9486	10921	11473	12223
29"	24"	108"	10150	11871	12470	13220
36"	20"	60"	7325	8377	8581	8956
36"	20"	72"	7867	9119	9247	9809
36"	20"	90"	10820	12341	12516	13266
36"	20"	108"	11672	13471	13604	14354
36"	24"	60"	7653	8660	9048	9423
36"	24"	72"	8317	9442	9891	10453
36"	24"	90"	11324	12759	13311	14061
36"	24"	108"	12235	13956	14555	15305

Lock Option add 81

C+D credenzas

CREDENZA 1/2" TOP, DRAWER AND CLOSED CABINET (CWSD)



PRODUCT FEATURES

- Heights:
 - 29"
 - 36"
- Depths:
 - 20"
 - 24"
- Width:
 - Two storage section - 60", 72"
 - Three storage section: 90", 108"
- Horizontal or Vertical Grain Directions are the same price
- One internal shelf
- Optional Lock available in Ebony or Polished Chrome finish

CREDENZA 1/2" TOP, DRAWER AND CLOSED CABINET (CWSD) PRICING

Height	Depth	Width	Laminate Case Construction			
			Veneer Top, Laminate Case	Backpainted Glass Top, Laminate Case	White Solid Surface Top, Laminate Case	Grey Solid Surface Top, Laminate Case
29"	20"	60"	6319	7371	7575	7950
29"	20"	72"	6686	7938	8066	8628
29"	20"	90"	9315	10836	11011	11761
29"	20"	108"	9905	11704	11837	12587
29"	24"	60"	6619	7626	8014	8389
29"	24"	72"	7077	8202	8651	9213
29"	24"	90"	9781	11216	11768	12518
29"	24"	108"	10382	12103	12702	13452
36"	20"	60"	7405	8457	8661	9036
36"	20"	72"	7852	9104	9232	9794
36"	20"	90"	10935	12456	12631	13381
36"	20"	108"	11662	13461	13594	14344
36"	24"	60"	7640	8647	9035	9410
36"	24"	72"	8210	9335	9784	10346
36"	24"	90"	11317	12752	13304	14054
36"	24"	108"	12082	13803	14402	15152

Lock Option add 81

CREDENZA 1/2" TOP, DRAWER AND CLOSED CABINET (CWS) PRICING (CONTINUED)

Height	Depth	Width	Veneer Case Construction			
			Veneer Top, Veneer Case	Backpainted Glass Top, Veneer Case	White Solid Surface Top, Veneer Case	Grey Solid Surface Top, Veneer Case
29"	20"	60"	7139	8191	8395	8770
29"	20"	72"	7616	8868	8996	9558
29"	20"	90"	10538	12059	12234	12984
29"	20"	108"	11298	13097	13230	13980
29"	24"	60"	7527	8534	8922	9297
29"	24"	72"	8077	9202	9651	10213
29"	24"	90"	11136	12571	13123	13873
29"	24"	108"	11875	13596	14195	14945
36"	20"	60"	8425	9477	9681	10056
36"	20"	72"	9017	10269	10397	10959
36"	20"	90"	12470	13991	14166	14916
36"	20"	108"	13397	15196	15329	16079
36"	24"	60"	8753	9760	10148	10523
36"	24"	72"	9467	10592	11041	11603
36"	24"	90"	12974	14409	14961	15711
36"	24"	108"	13960	15681	16280	17030

Lock Option add 81